

V-TORK®

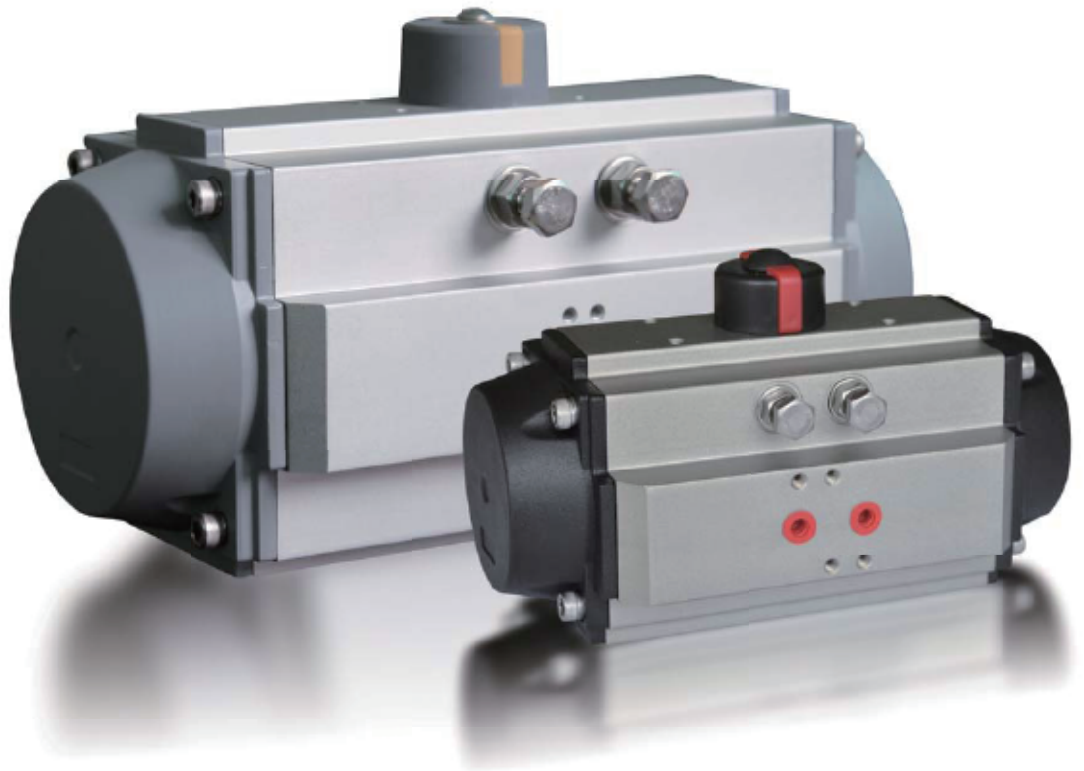

VT Series Rack and Pinion Pneumatic Actuator



High performance and high reliability
Fully compliant with the latest international standards and regulations
More applicable to a wide range of specifications and higher cost performance
Compact design is better suited for a variety of industrial applications



ATEX2014/34/EU

Design

VT series rack and pinion pneumatic actuators apply innovative drive mechanism, integrating the latest pneumatic actuator technology and materials. The series is designed as per extensive field mounting and application experience with following product strengths:

- ☆ High performance and high reliability
- ☆ Fully compliant with the latest international standards and regulations
- ☆ More applicable to a wide range of specifications and higher cost performance
- ☆ Compact design is better suited for a variety of industrial applications

Structure

1. Integrate and compact design utilizes the same body and end caps for double acting and spring return actuator in the same model. It also benefits less spare parts inventory and is greatly convenient for customers' field application by adding or removing spring cartridges.

2. Fully compliant with the latest international standards including ISO5211, DIN3337 and VDI/VDE3845, etc. Fully compliant with NUMAR standard and convenient to replace or mount accessories including solenoid valves, limit switches.

3. Apply rack and pinion with double pistons in advantages of compact structure, high cycle life, and swift operation. It is convenient to switch rotation direction only by inverting the pistons for symmetrical mounting position design.

4. Dual independent travel stoppers can be conveniently and precisely implement $\pm 4^\circ$ adjustments externally in two directions, allowing actuators in alignment with valve on both the opening and closing phases of the stroke.

5. The composite bearings and guides on pinion and piston ensure precise operation, low friction and high life cycle, preventing output shaft from fractures.

6. Integrate design of bearing and guide improves security with high resistance to fractures and long cycle life for Nickel plating process.

7. Rack and pinion tooth in high precision realize less clearance, accurate drive and high output power.

8. Extruded aluminum body is processed with corrosion resistance internally and externally. Fine ground cylinder surface lead to low friction coefficient and high cycle life.

9. Modularized preload spring cartridges with special coating is applicable to a wide range of scenarios with high security and anticorrosion.

10. High-quality bearings are of reliable sealing, low friction, high cycle life and wide range of application temperature.

11. All of the internal and external fasteners are made in long term corrosion-resistant stainless steel.

12. Multifunctional position indicator with slot in compliance with NAMUR standard offers simplicity and clarity for visual indication. Connection to a variety of standard and common sensors can be easily realized.

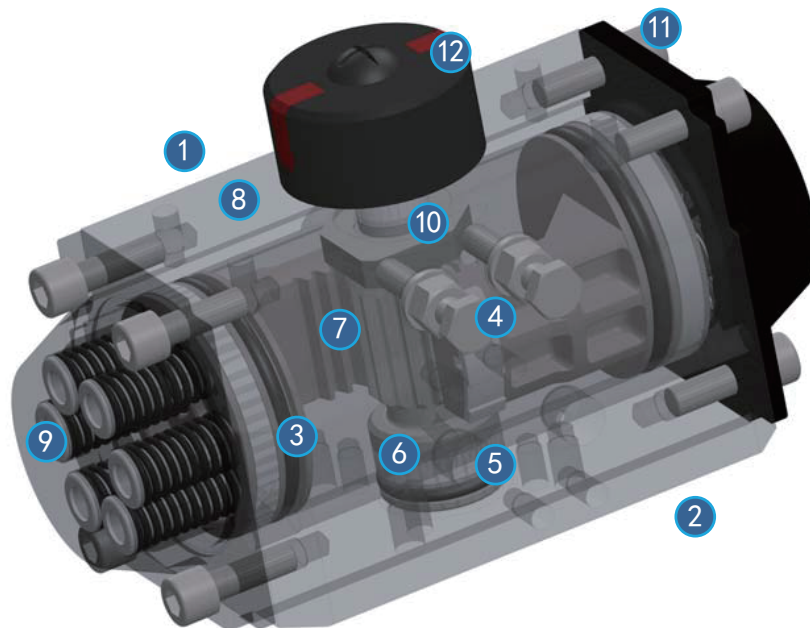

Product Selection Range, Accessories and Quality Management

Selection Range:

A: Actuators in all specifications are supplied with 304 or 316 stainless steel output shafts as requested.

B: For applications under extremely high and low temperature, all models are supplied with corresponding FPM or silicone rubber O-ring with special lubricant.

C: The female pinion drive is standard with double square and diagonal square output drive at the bottom, and optional with keyed drive, flat head drive. And customized design as per customers' specific requirements is also available.

Quality Management:

- VT series pneumatic actuators production process is fully compliant with ISO9001.
- 100% of all units are factory pressure and leak tested and externally marked with dedicated serial number for traceability.
- 100% of all units are individually boxed with suitable cardboard carton for protection and appropriately labeled in detail for identification.

Optional Accessories:

- Bracket
- Solenoid Valve
- Proximity Sensor
- Gear Box(Manual Gear Override)
- Complete set of square output shaft in reduced sizes
- Connector
- Limit Switch Box
- Positioner

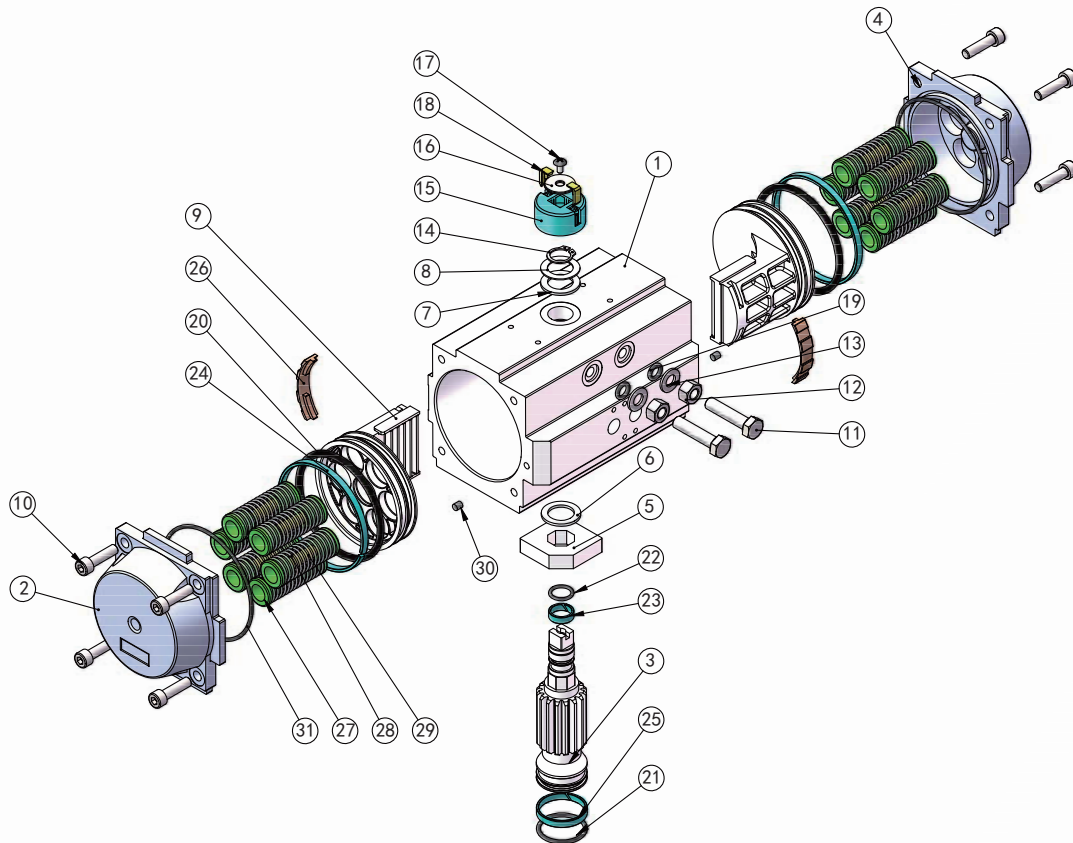

Item No.	Description	Materials	Qty.	Item No.	Description	Materials	Qty.	Item No.	Description	Materials	Qty.
1	Body	Aluminum Alloy	1	12	Travel Stop Nut	Stainless Steel	2	23	Upper Pinion Bearing	Advanced Polymer	1
2	Left End Cap	Aluminum Alloy	1	13	Travel Stop Washer	Stainless Steel	2	24	Piston Wear Bearing	Advanced Polymer	2
3	Pinion	45# Steel	1	14	Retaining Ring	Spring Steel	1	25	Lower Pinion Bearing	Advanced Polymer	1
4	Right End Cap	Aluminum Alloy	1	15	Indicator	Advanced Polymer	1	26	Piston Skate	Advanced Polymer	2
5	OCH-CAM	45# Steel	1	16	Indicator Thrust Bearing	Stainless Steel	1	27	Spring Seat	Advanced Polymer	24
6	Upper Pinion Thrust Bearing	Advanced Polymer	1	17	Flat Head Cross Bolt	Stainless Steel	1	28	Spring	Spring Steel	12
7	Thrust Bearing	Advanced Polymer	1	18	Color Code	Advanced Polymer	2	29	Straining Beam	Copper Pipe	12
8	Thrust Washer	Stainless Steel	1	19	O-ring (Travel Stop)	NBR	2	30	Plug	NBR	2
9	Travel Stop Piston	Aluminum Alloy	2	20	O-ring (Piston)	NBR	2	31	O-ring (End Cap)	NBR	2
10	End Cap Bolt	Stainless Steel	8	21	O-ring (Lower Pinion)	NBR	1				
11	Travel Stop	Stainless Steel	2	22	O-ring (Upper Pinion)	NBR	1				

Technical Data (Metric Unit)

Model	V T032		V T050		V T065		V T075		V T085		V T095		V T110		V T125		V T140		V T160		V T190		V T210		V T240		V T270		V T300		V T350		V T400	
	D	S	D	S	D	S	D	S	D	S	D	S	D	S	D	S	D	S	D	S	D	S	D	S	D	S	D	S	D	S	D	S	D	S
Diameter(mm)	32		50		65		75		85		95		110		125		140		160		190		210		240		270		300		350		400	
Air Volume Opening(L)	0.03		0.09		0.19		0.30		0.44		0.88		0.83		1.41		1.76		2.85		4.75		6.60		11.40		15.80		19.09		27.65		42.81	
Air Volume Closing(L)	0.04		0.15		0.32		0.50		0.66		1.17		1.27		2.13		2.72		4.08		7.20		10.29		15.10		18.80		28.23		44.10		62.05	
Opening Time(s)	0.3		0.3	0.9	0.4	0.9	0.4	0.9	0.9	1.0	0.9	1.4	0.9	1.4	1.3	2.4	1.3	2.8	2.0	4.8	2.2	2.4	2.9	3.4	3.2	3.8	4.4	5.0	5.0	6.0	6.2	7.4	7.5	9.6
Closing Time(s)	0.4		0.4	0.7	0.4	0.8	0.4	0.9	0.9	1.2	1.0	1.4	1.0	1.6	1.4	2.4	1.4	3.0	2.4	4.9	2.6	3.0	3.8	4.1	3.7	4.0	4.9	5.5	6.0	6.8	7.2	8.4	8.5	10.6
Weight (kg)	0.47		1.13	1.25	1.97	2.21	2.93	3.29	3.78	4.26	5.14	5.86	6.09	7.17	10.86	12.54	13.77	15.93	20.15	23.75	28.41	33.81	40.03	48.43	52.6	77.76	73.64	90.6	108	135.6	146.7	188.1	220.5	283.5

Notice: (A) The operation time above are measured in following experimental conditions:

1.For model 32-160

(1)Room temperature (2)Actuator stroke 90° (3)Solenoid valve with orifice of 4 mm and a flow capacity Qn400L/min (4)Inside pipe diameter 6 mm (5) Neutral clean air (6)Air supply pressure 5.5 bar

(7)Actuator without external resistance load

2.For model 190-400

(1)Room temperature (2)Actuator stroke 90° (3)Solenoid valve with orifice of 12 mm and a flow capacity Qn5100L/min (4)Inside pipe diameter 8 mm (5)Neutral clean air (6)Air supply pressure 5.5 bar

(7)Actuator without external resistance load

Cautions: obviously on the field applications when one or more parameters are different from above, the operation time will be different. Air consumption rest with air supply, open/switch stroke, air volume and action cycle times.

Expressions:

$$L/min = \text{Air volume}(\text{opening air volume} + \text{closing air volume}) \times \frac{[\text{Air Supply}(\text{Kpa}) + 101.3]}{101.3} \times \text{Action times}(/min)$$

High- Quality Products and Patent Qualification Certificates



Various Qualifications And Certifications Verified By International Authorities

- All VTORK (VT) products have been professionally designed with optimization.
- 100% of all units are factory pressure and leak tested.
- 100% of all units are externally marked with dedicated serial number for traceability.
- 100% of all units are individually boxed with suitable cardboard carton for protection and appropriately labeled in detail for identification.



Numerous Invention Patent Certifications



Sample Reference

Applicable Specification:
VT050~VT160

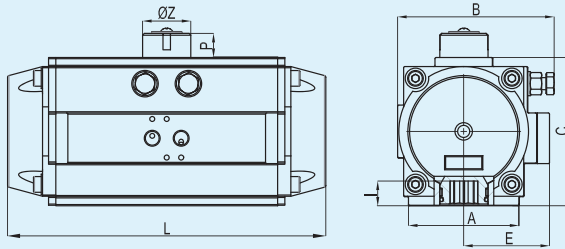

Applicable Specification:
VT032

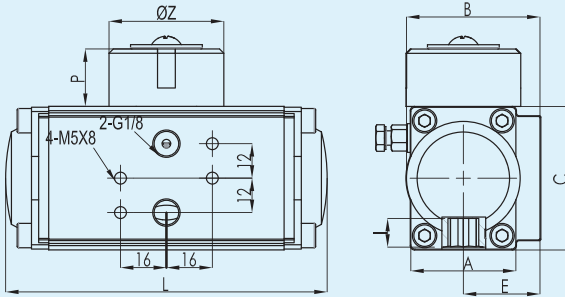

Applicable Specification:
VT190~VT350

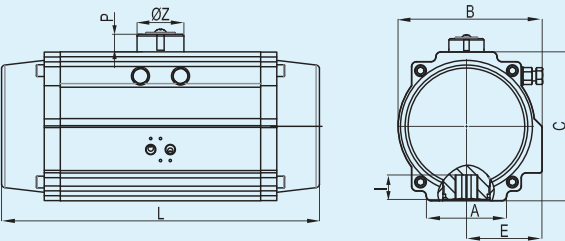

Applicable Specification:
VT400

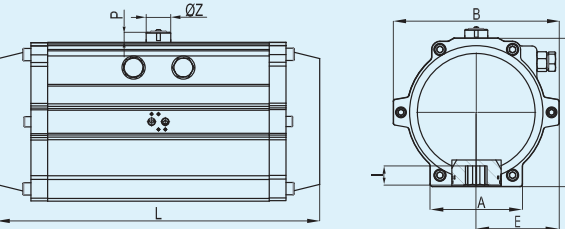

Top View

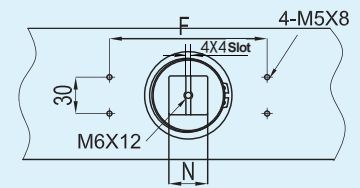

Air Supply Interface

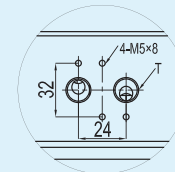

G1/4 NAMUR Standard
Applicable to VT50-VT210

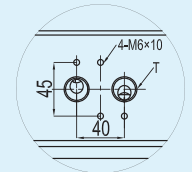

G1/2 NAMUR Standard
Applicable to VT240-VT400

Bottom View

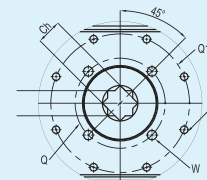

Applicable Specification : VT350

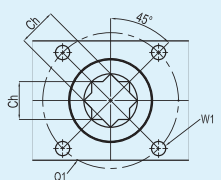

Applicable Specification :
VT032, VT210 - VT300

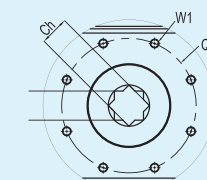

Applicable Specification : VT400

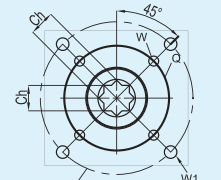

Applicable Specification :
VT50 - VT190

VT Series Pneumatic Actuator Dimension Table (Unit: mm)

Model	A	B	C	L	E	F	P	ØZ	N	I	Flange Type	Q	Q1	W	W1	Ch	T
VT032	37	47	50	110	27	50	20	40	10	10	F03	-	36	-	M5×8	9×9	G1/8"
VT050	45	70.5	70	154	41.5	80	20	40	10	12	F03/05	36	50	M5×7.5	M6×9	11×11	G1/4"
VT065	62	89.5	89	189	51.5	80	20	40	10	16	F05/07	50	70	M6×9	M8×12	14×14	G1/4"
VT075	68	102.5	100	210	59	80	20	40	14	16	F05/07	50	70	M6×9	M8×12	14×14	G1/4"
VT085	68	112.5	113	229	63.5	80	20	40	14	19	F05/07	50	70	M6×9	M8×12	17×17	G1/4"
VT095	92	126	123	264	71	80	20	40	14	19	F05/07	50	70	M6×9	M8×12	17×17	G1/4"
VT110	93	138.5	136	266	76.5	80	20	40	14	19	F07/10	70	102	M8×12	M10×15	17×17	G1/4"
VT125	96	157	161	337	85	80	30	56	22	25	F07/10	70	102	M8×12	M10×15	22×22	G1/4"
VT140	110	178	178	377	97	80/130	30	56	22	31	F10/12	102	125	M10×15	M12×18	27×27	G1/4"
VT160	112	196	200	414	106	80/130	30	56	22	31	F10/12	102	125	M10×15	M12×18	27×27	G1/4"
VT190	136	216.5	232	490	112	130	30	56	22	41	F10/14	102	140	M10×15	M16×24	36×36	G1/4"
VT210	140	235.5	255	550	120	130	30	80	32.5	40	F14	-	140	-	M16×24	36×36	G1/4"
VT240	159	262	292	602	131	130	30	80	32.5	50	F16	-	165	-	M20×25	46×46	G1/2"
VT270	159	295	331	672	147.5	130	30	80	32.5	50	F16	-	165	-	M20×25	46×46	G1/2"
VT300	180	335	354	784	173	130	30	80	32.5	50	F16	-	165	-	M20×25	46×46	G1/2"
VT350	270	385	410	845	195	130	30	80	32.5	50	F16/F25	165	254	M20×25	M16×24	46×46	G1/2"
VT400	290	520	466	956	260	130	30	80	32.5	60	F25	-	254	-	M16×24		G1/2"

Model	Type	Spring Qty.	Flange Type	Square	Option	Sealing Part	
VT032	D=Double Acting S=Spring Return	Dedicated to Spring Return	F03	9×9	End Cap Color RAL ■ 7046 ■ 9004 ■ 5021 ■ 3020 ■ 6002 ■ 5015 Cylinder Type P Smooth Surface& Hard Anodized S Sandblasted Surface&Hard Anodized (Color:Grey) H Sandblasted Surface&Hard Anodized (Color:Dark Grey) F Sandblasted Surface&Hard Anodized&PTFE Coated	Standard Nitrile Rubber -18°C~+80°C	
VT050			F03/05	11×11			
VT065			F05/07	14×14			
VT075			F05/07	14×14			
VT085			F05/07	17×17			
VT095			4	F05/07			17×17
VT110			5	F07/10			17×17
VT125			6	F07/10			22×22
VT140			7	F10/12			27×27
VT160			8	F10/12			27×27
VT190		9	F10/14	36×36			
VT210		10	F14	36×36			
VT240		11	F16	46×46			
VT270		12	F16	46×46			
VT300		F16	46×46				
VT350		F16/25	46×46				
VT400		F25	55×55				

Remarks:

1. The standard rotation of double acting and spring return is clockwise to close.
2. Sealing parts come standard with normal temperature ranges of -18°C to 80°C, Corresponding sealing types are available for environment at high or low temperature.
3. Please refer to brochure for technical parameter details. VTORK has the capability to provide customized service based on standard products. Please contact VTORK for details.
4. Customized service including but not limited to:

- Color combination;
- Flange and square;
- Higher protection grade;

Model Selection Example:

Example1: VT095D F07/10 17 P7046

Description: Actuator model VT095, double acting, ISO flange F07&F10, 17mm diagonal square with standard indicator as well as standard nitrile rubber sealing, P body, cap color grey(RAL7046).

Example2: VT190S12 F10/14 36 S5021 HT F0

Description: Actuator model VT190, single acting spring return, 12springs, ISO flange F10&14, 36 mm diagonal square, S body, cap color green (RAL5021), fluororubber rubber sealing.

⚠ Notice

Pressure-temperature ratings and other performance data published in this catalog have been developed from our design calculation, in-house testing, field reports provided by our customers and/or published official standards or specifications. They are good only to cover typical applications as a general guideline to users of VTORK products introduced in this catalog. For any specific application, users are kindly requested to contact VTORK for technical advice, or to carry out their own study and evaluation for proving suitability of these products to such an application. Failure to follow this request could result in property damage and/or personal injury, for which we shall not be liable. While this catalog has been compiled with the utmost care, we assume no responsibility for errors, impropriety or inadequacy. Any information provided in this catalog is subject to from-time-to-time change without notice for error rectification, product discontinuation, design modification, new product introduction or any other cause that VTORK considers necessary. This edition cancels all previous issues.

The final interpretation right of this sample belongs to VTORK Technology(Wuxi) Co.,Ltd.